

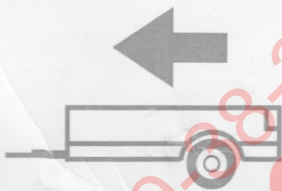

KIA CEE'D 5D

2018 -

Cat. No. K/069



1500kg



75kg

D = 08,41kN

+7 (495) 669-38-36

D (kN) =



MAX kg

x

MAX kg

x 0,00981



MAX kg

+

MAX kg



IMIOLA HAK-POL

96-111 KOWIESY, CHOJNATA 23A, POLAND

Tel. + 48 46 831 73 31, fax +48 831 74 29

e-mail: office@imiola.pl, www.imiola.pl

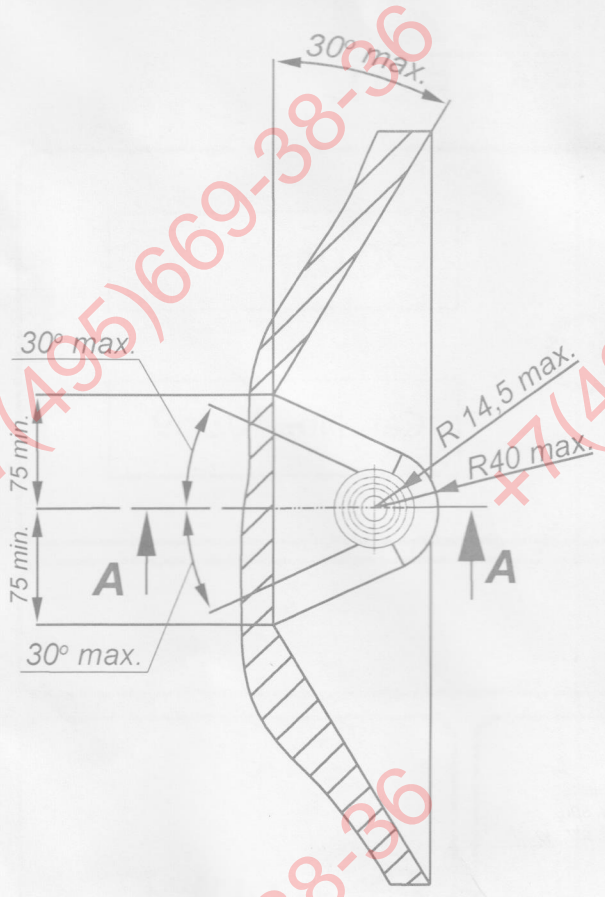

PRZEKRÓJ A-A

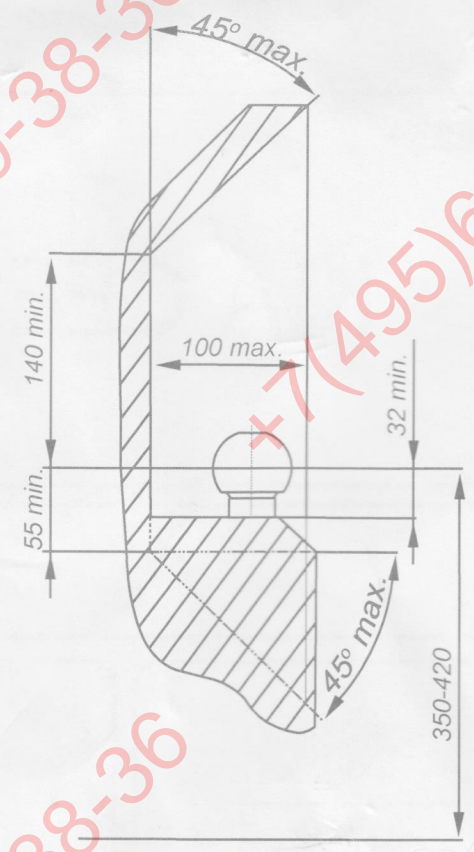

ФАРКОП.РФ

PL Należy zagwarantować przestrzeń swobodną według załącznika VII, rysunek 25a/b Regulaminu EKG ONZ 55.01 przy dopuszczalnym ciężarze całkowitym pojazdu.

F L'espace libre doit être garanti conformément à l'annexe VII, illustration de la règlement 55.01 CE pour un poids total en charge autorisé du véhicule.

GB The clearance specified in appendix VII, diagram 25a/b of Regulation No. 55.01 UN EU must be guaranteed at laden weight of the vehicle.





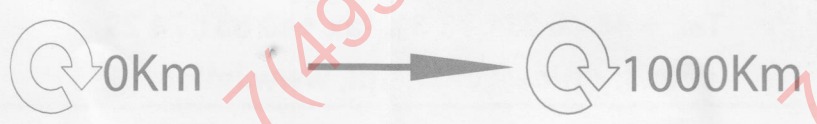

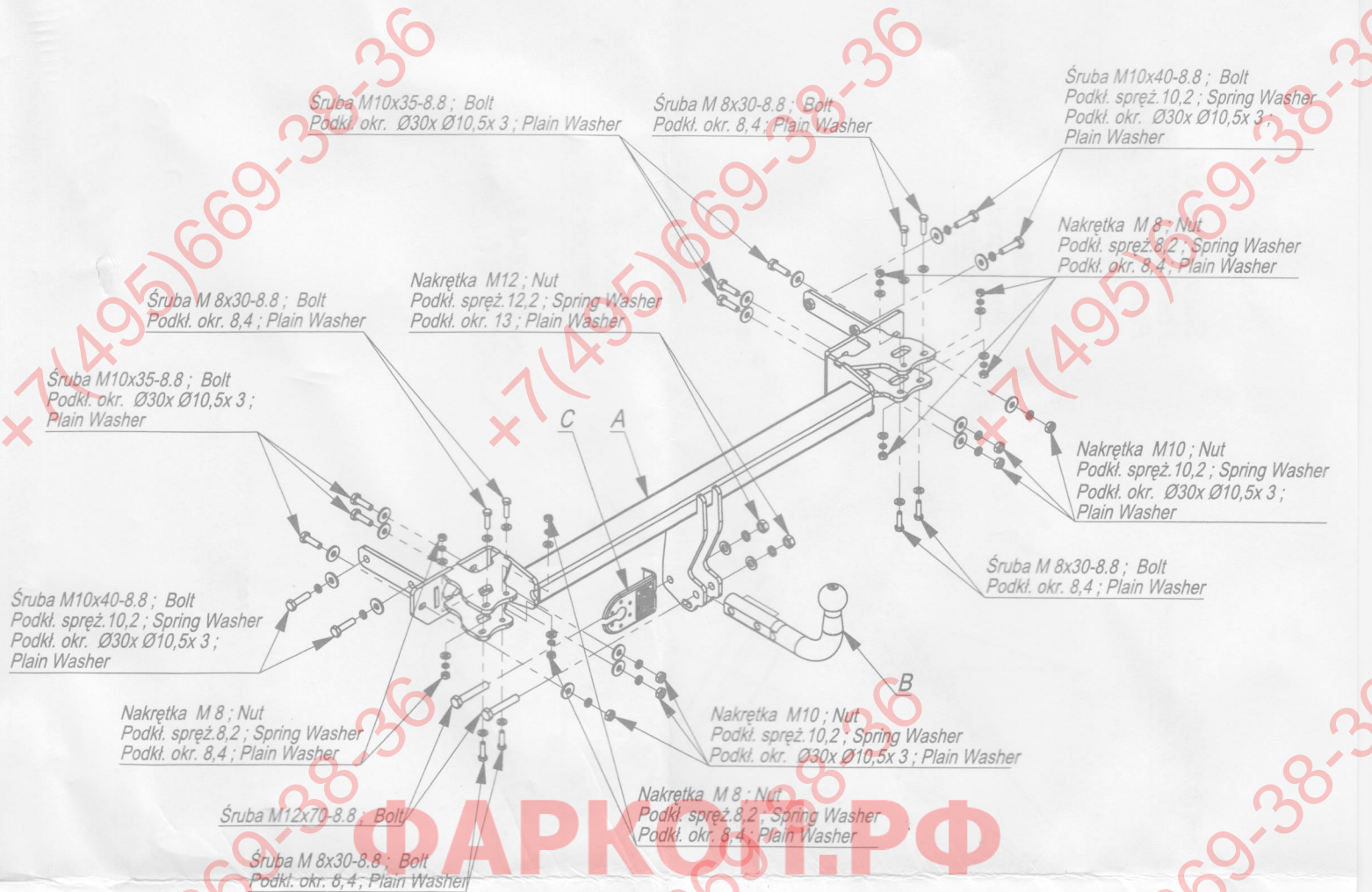
D Der Freiraum nach Anhang VII, Abbildung 25a/b der Vorschriften 55.01 EG ist zu gew 25a/b abzuhalten bei zulässigem Gesamtgewicht des Fahrzeuges.

Moment skracający dla śrub i nakrętek (8.8) Torque settings for nuts and bolts (8.8)	
M8	25Nm
M10	55Nm
M12	85Nm
M14	135Nm
M16	195Nm

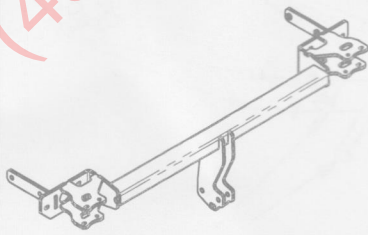

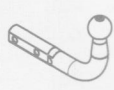

+7 (495) 669-38-36

	A	x1		M12x70	2
				M10x40	4
				M10x35	6
				M 8x30	8
	B	x1		M12	2
				M10	6
				M8	8
	C	x1		Ø30xØ10,5x 3	16
				13	2
				8,4	16
				12,2	2
				10,2	10
				8,2	8

Śruba M10x35-8.8 ; Bolt
Podkt. okr. Ø30x Ø10,5x 3 ; Plain Washer

Nakrętka M 8 ; Nut
Podkt. spręż.8,2 ; Spring Washer
Podkt. okr. 8,4 ; Plain Washer

Śruba M 8x30-8.8 ; Bolt
Podkt. okr. 8,4 ; Plain Washer

Nakrętka M 8 ; Nut
Podkt. spręż.8,2 ; Spring Washer
Podkt. okr. 8,4 ; Plain Washer

Śruba M10x35-8.8 ; Bolt
Podkt. okr. Ø30x Ø10,5x 3 ;
Plain Washer

Śruba M10x40-8.8 ; Bolt
Podkt. spręż.10,2 ; Spring Washer
Podkt. okr. Ø30x Ø10,5x 3 ;
Plain Washer

Śruba M12x70-8.8 ; Bolt

Śruba M 8x30-8.8 ; Bolt
Podkt. okr. 8,4 ; Plain Washer

Pkt. 2

Nakrętka M12 ; Nut
Podkt. spręż.12,2 ; Spring Washer
Podkt. okr. 13 ; Plain Washer

Pkt. 3

Pkt. 3

Nakrętka M10 ; Nut
Podkt. spręż.10,2 ; Spring Washer
Podkt. okr. Ø30x Ø10,5x 3 ; Plain Washer

Śruba M 8x30-8.8 ; Bolt
Podkt. okr. 8,4 ; Plain Washer

Śruba M10x40-8.8 ; Bolt
Podkt. spręż.10,2 ; Spring Washer
Podkt. okr. Ø30x Ø10,5x 3 ;
Plain Washer

Nakrętka M 8 ; Nut
Podkt. spręż.8,2 ; Spring Washer
Podkt. okr. 8,4 ; Plain Washer

Nakrętka M10 ; Nut
Podkt. spręż.10,2 ; Spring Washer
Podkt. okr. Ø30x Ø10,5x 3 ;
Plain Washer

Śruba M 8x30-8.8 ; Bolt
Podkt. okr. 8,4 ; Plain Washer

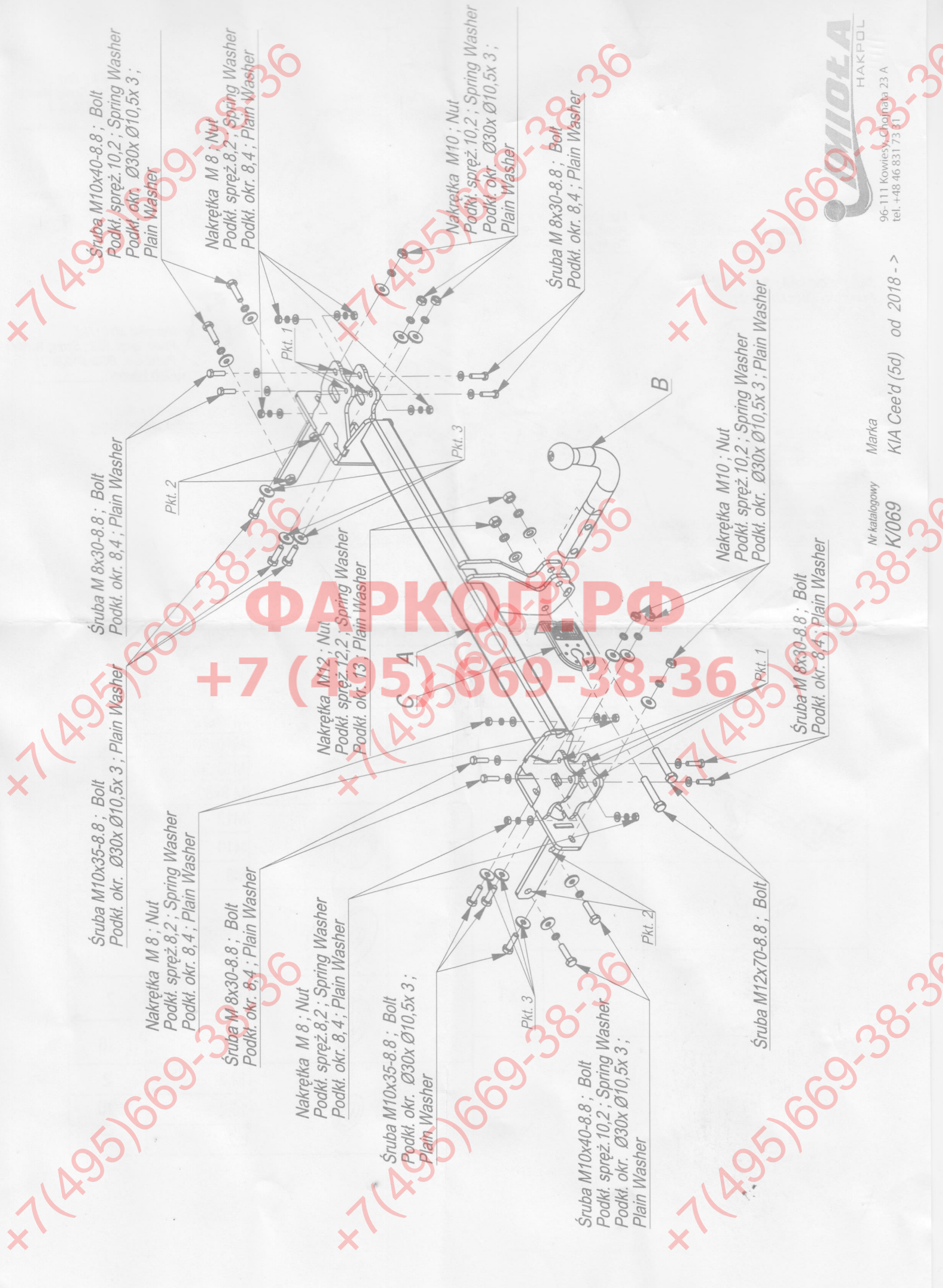

+7(495)669-38-36

ΦΑΡΚΟΛΡΦ
+7(495)669-38-36

+7(495)669-38-36

+7(495)669-38-36

+7(495)669-38-36



Nr katalogowy
K/069

Marka
KIA Cee'd (5d) od 2018 ->

96-111 Kowiesy, Chojnaka 23 A
tel. +48 46 831 73 81

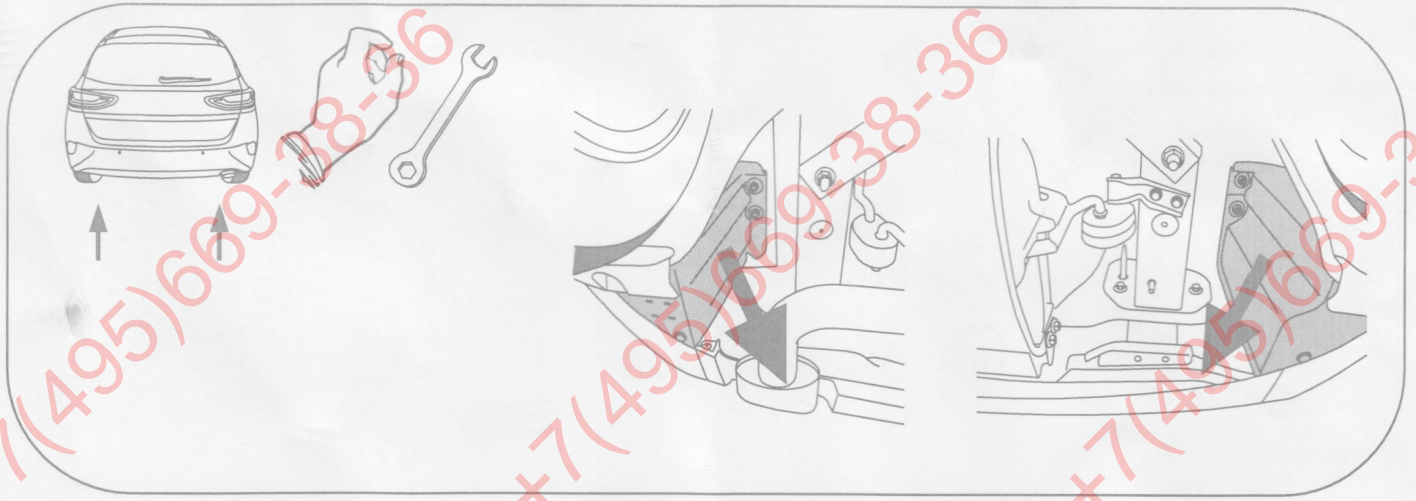



ФАРКОП.РФ

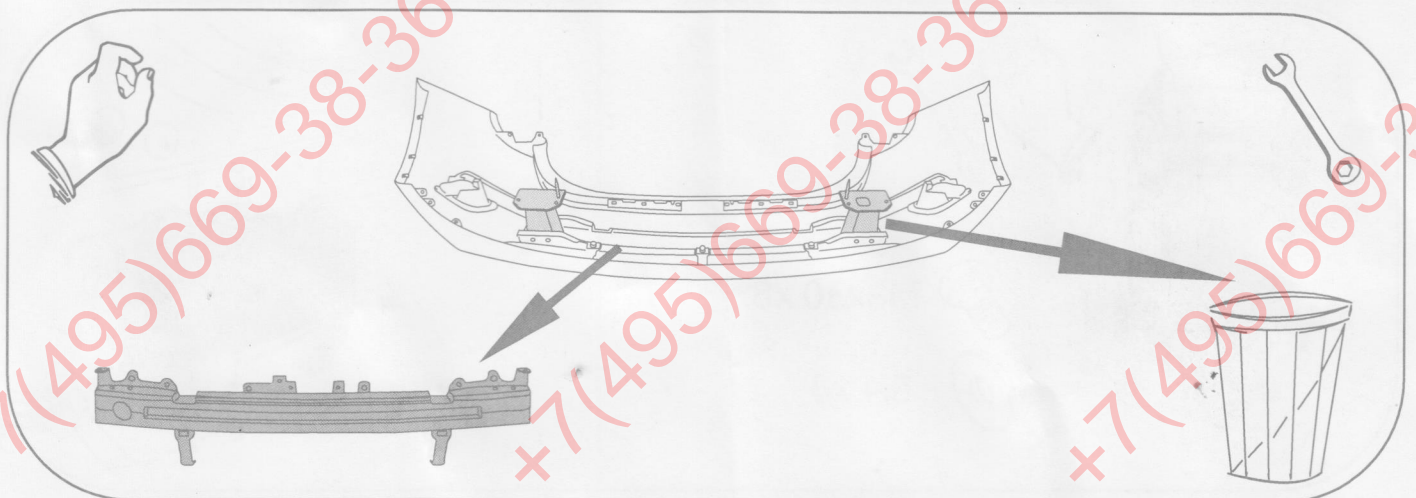
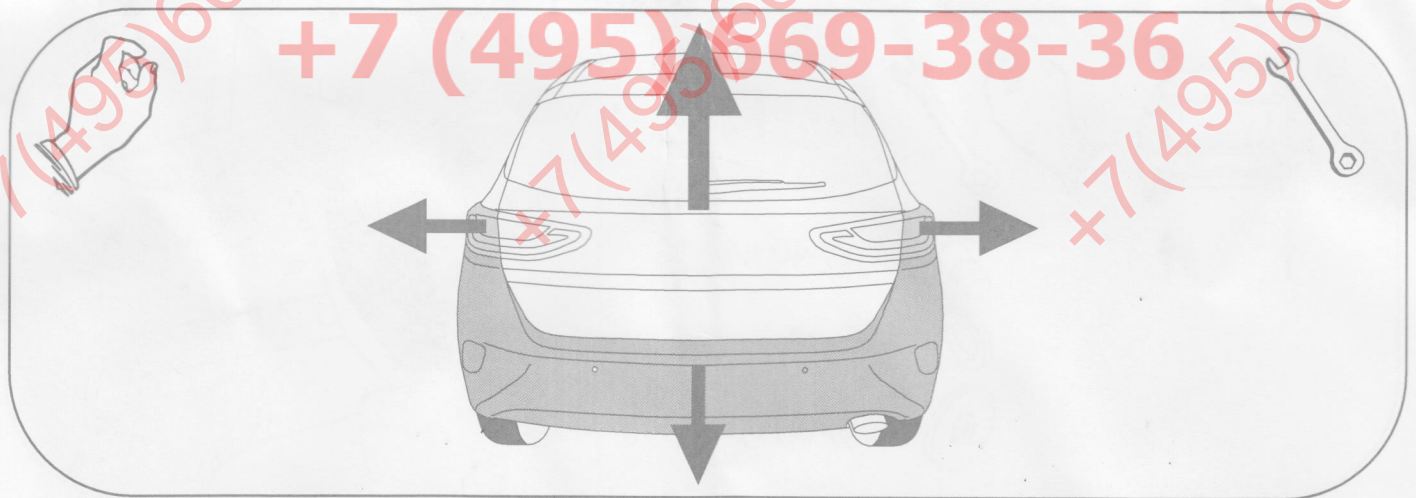

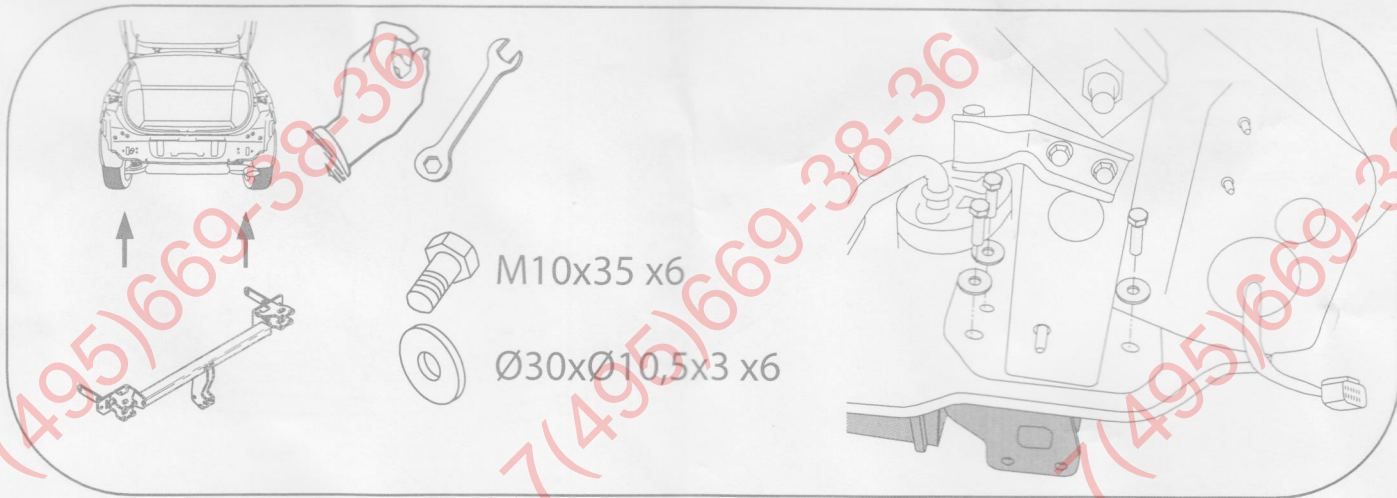
+7 (495) 669-38-36





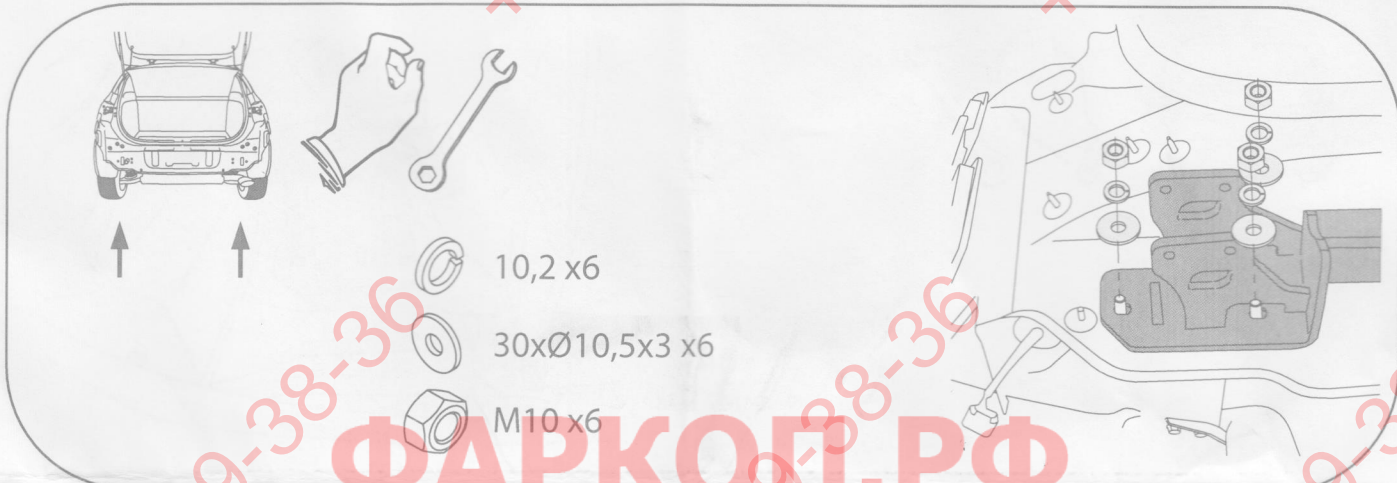



-  M10x35 x6
-  Ø30xØ10,5x3 x6

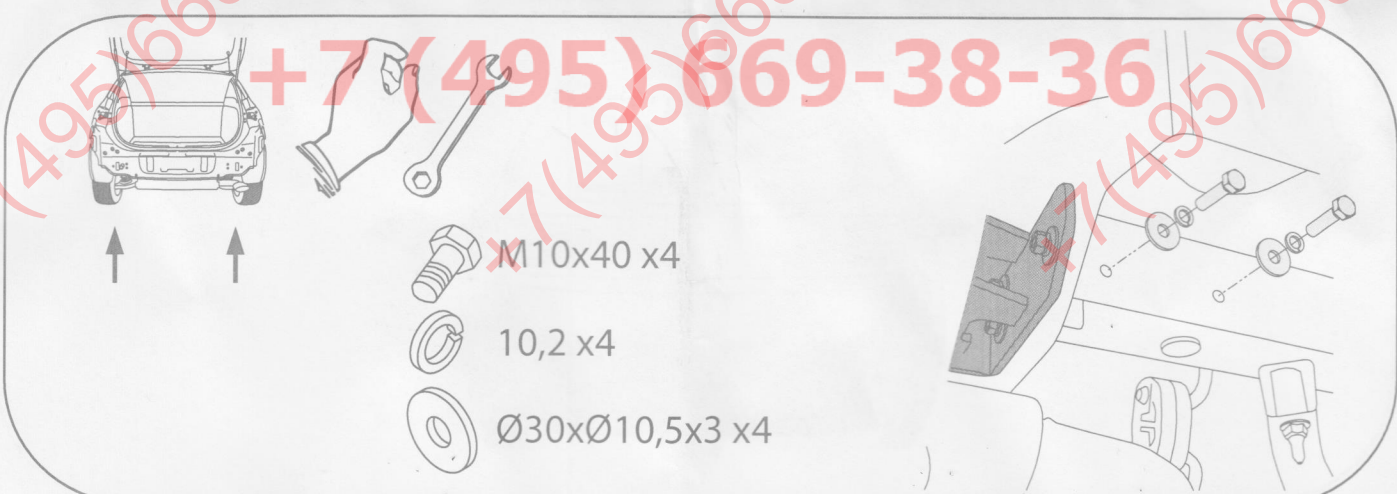



-  10,2 x6
-  30xØ10,5x3 x6
-  M10 x6

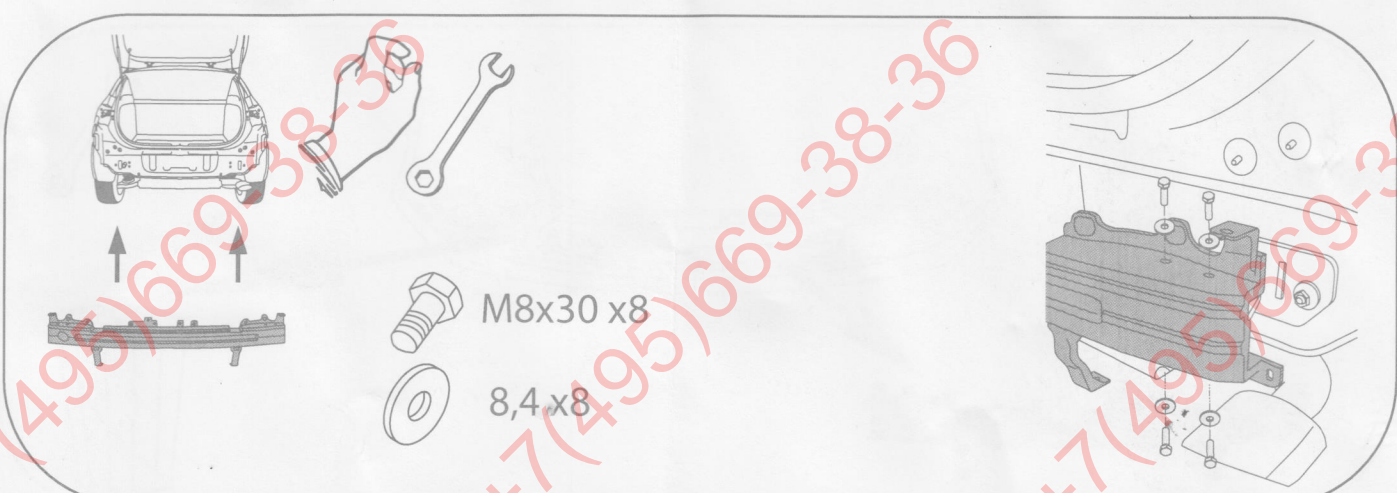

-  M10x40 x4
-  10,2 x4
-  Ø30xØ10,5x3 x4



-  M8x30 x8
-  8,4x8

ФАРКОП.РФ

+7(495) 669-38-36

x7(495)669-38-36

x7(495)669-38-36

x7(495)669-38-36

x7(495)669-38-36

x7(495)669-38-36

x7(495)669-38-36

x7(495)669-38-36

x7(495)669-38-36

x7(495)669-38-36

x7(495)669-38-36

x7(495)669-38-36

x7(495)669-38-36

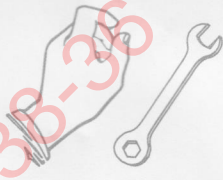

-  8,2 x8
-  8,4 x8
-  M8 x8

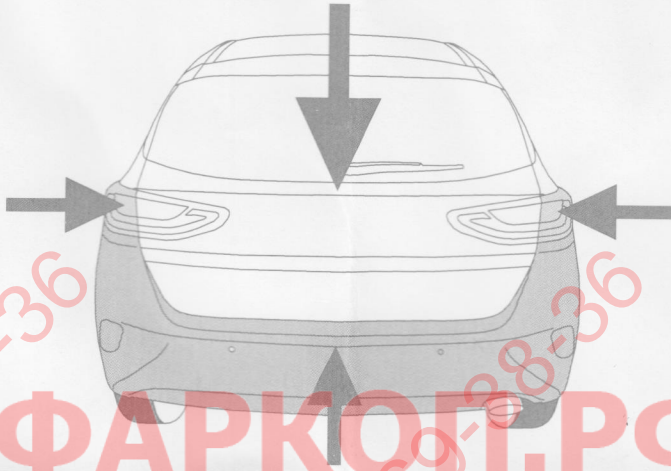
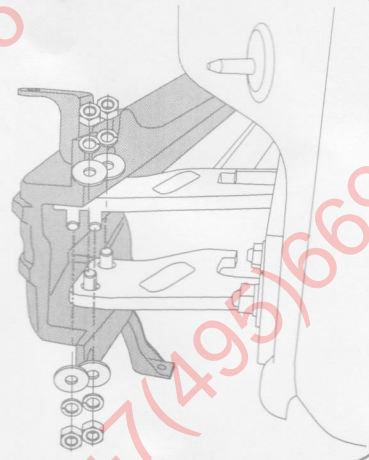

ФАРКОП.РФ

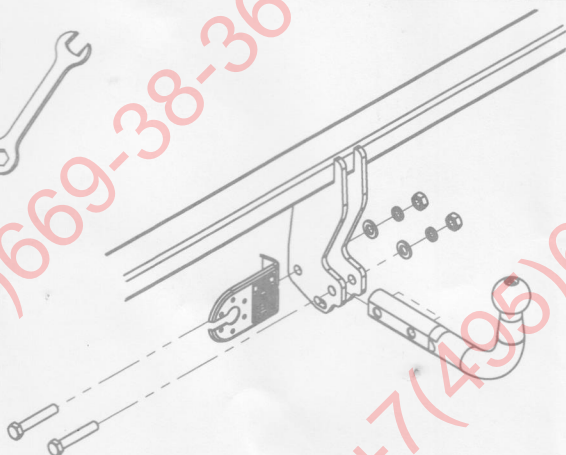
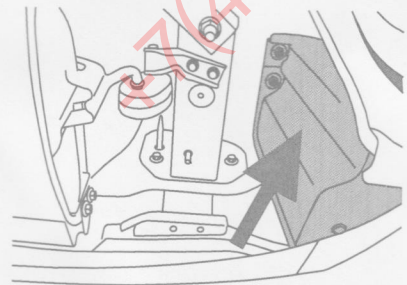
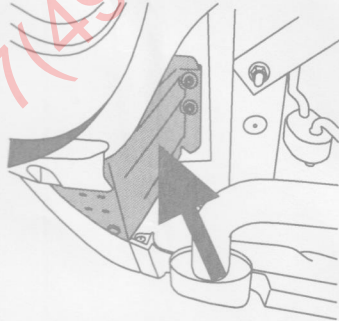

-  M12x70 x2
-  12,2 x2
-  13 x2
-  M12 x2